

**MotorGuide®**

**NEVER STOP.**

# WIRELESS SERIES

## OWNER'S INSTRUCTION MANUAL

INSTALLATION  
OPERATION  
MAINTENANCE



8M4000137



835 W. 41<sup>st</sup> Street  
Tulsa, Oklahoma 74107

[www.motorguide.com](http://www.motorguide.com)

© 2005, MotorGuide

**FCC and IC Compliance Statement**

FCC ID #MVUFP01, MVUFP02

IC: 6094A-FP01, 6094A-FP02

This device complies with part 15 of the FCC Rules.  
Operation is subject to the following two conditions:

1. This device may not cause harmful interference,  
and
2. This device must accept any interference received,  
including interference that may cause undesired  
operation.

This device complies with FCC Rules. Changes or  
modifications not expressly approved by MotorGuide  
could void the user's authority to operate the  
equipment .

# Congratulations

... on your purchase of the MotorGuide Wireless Trolling Motor. This motor has been designed, engineered, and manufactured to give you the best possible dependability and exceptional performance for years of enjoyment. These features offer an unrivaled fishing experience:

- ▶ Durability
- ▶ Oversized brushes for efficient and dependable power
- ▶ Fully Remote Operation Integrated, Quick Release Mount
- ▶ Modular Digital Electronics Three-year Limited Warranty

**MotorGuide®**  
**NEVER STOP.**

## IMPORTANT!!

### REGISTER YOUR PRODUCT

The warranty registration card (located inside the box) should be completed and mailed to MotorGuide to validate your warranty.

**WARRANTY CARD  
REGISTRATION  
IS INCLUDED IN THE BOX  
AND IS SEPARATE FROM  
THIS MANUAL.**

**PLEASE FILL OUT  
IMMEDIATELY AND MAIL TO  
VALIDATE YOUR  
WARRANTY.**

**MotorGuide®**  
**NEVER STOP.**

At **MotorGuide**, we've taken all the victories, failures, blood, sweat, tears, hours, days and years to heart and built what are possibly the best performing, most reliable trolling motors ever.

It's a result of re-engineering from top to bottom, from our new digital modules, to new switches and props. Why? The reason is simple. To give you the advantage—and, in this case it's a digital advantage.

Because at MotorGuide, we believe there are some things you should **Never Stop** doing,

**NEVER STOP LEARNING,  
NEVER STOP IMPROVING,  
AND NEVER EVER STOP  
FISHING.**

# TABLE OF CONTENTS

## General Information

GENERAL INFORMATION .....	2
Safety DO's and DON'Ts .....	3
Operating Safety .....	4
NOTES: .....	5

## Features & Components

FEATURES.....	6
Remote Capabilities .....	6
COMPONENTS .....	7
Wireless Remote Foot-Pedal .....	7
Lower Unit .....	7
Column .....	7
Top Housing .....	7
Cradle Lock™ Mount .....	8
Battery Indicator .....	8

## Installation

INSTALLATION .....	10
Mount Installation .....	10
Wiring & Battery Information .....	13
Wire & Cable Routing .....	13
Establishing a Common Ground.....	14
Recommendations .....	14
Activating the Foot-Pedal Electronic ID .....	17
Erasing the Receiver's Memory .....	17

## Motor & Mount Operation

MOTOR & MOUNT OPERATION .....	18
Adjusting the Motor Depth and Deploying the Motor .....	18
Stowing the Motor .....	19
Operating the Foot-Pedal.....	20

## **Maintenance**

MAINTENANCE .....	21
Foot-Pedal Battery Replacement .....	21
Care & Cleaning Instructions .....	22
Customer Responsibilities.....	22
Battery.....	22
Freezing Temperature Storage.....	23
Installing or Replacing the Propeller .....	23

## **Troubleshooting & Accessories**

TROUBLESHOOTING .....	25
Frequently Asked Questions .....	25
MOTORGUIDE ACCESSORIES	28

## **Warranty**

MOTORGUIDE LIMITED THREE-YEAR WARRANTY .....	29
--	----



# MOTORGUIDE WIRELESS

---

---

## GENERAL INFORMATION

Please read and retain this manual. The information within describes the proper procedures for safely installing, operating and maintaining your motor.

 **WARNING**

Failure to follow a safety WARNING can result in bodily injury.

 **CAUTION**

Failure to observe CAUTION instructions can result in failure or damage to the product or equipment.

 **INFORMATION**

The information symbol signifies important information about your trolling motor.

 **NOTE**

The Note symbol signifies a statement calling attention to general information about your trolling motor.

The description and specifications contained herein were in effect at the time this manual was approved for printing. MotorGuide, whose policy is one of continual improvement, reserves the right to discontinue models at any time, to change specifications, designs, and methods of procedure without notice and without incurring obligation.

Safety and operating information that is practiced along with good common sense can help prevent personal injury and product damage.

 **CAUTION**

**If the motor automatically throttles back, it indicates something may be wrong with the motor and it should be taken in for service.**

 **CAUTION**

**A slight voltage drain occurs when the trolling motor is continually connected to the battery for extended periods of time. To prevent battery drain when not in use for an extended period, disconnect the trolling motor from the power source.**

# MOTORGUIDE WIRELESS

---

---



## CAUTION







**Disconnect the trolling motor from the battery(s) before charging.**

## How to Use This Manual

Review the following information carefully. These notices will alert you to potential dangers and important information.

The observance of **WARNINGS and CAUTIONS** alone does not eliminate the possibility of personal injury or product damage. Your close attention to the performance of recommended service procedures and the practice of responsible personal safety are major accident prevention measures.

## Safety DO's and DON'Ts

-  Do not allow children to operate the trolling motor without adult supervision.
-  Do not modify the unit in any way or add accessories other than approved MotorGuide accessories.
-  Do not power-wash your trolling motor.
-  Do disconnect the power from the motor when replacing the prop, removing debris around the prop, charging batteries, putting your boat on a trailer or when the motor is not in use.
-  Do make sure the foot-pedal is secured and the motor is securely locked into the stowed position when using a gasoline motor to move to another location, or when putting your boat on a trailer.
-  Do secure loose items on your boat before traveling at high speeds across the water.
-  Do always connect to the battery through a power plug or a power switch which can be easily disconnected. Never "hardwire" the motor directly to the batteries. Use the recommended circuit breaker to protect the wires.



# MOTORGUIDE WIRELESS

---

---



**Circuit Protection** – MotorGuide recommends installing a 50 amp manual-reset circuit breaker and power switch in line with the trolling motor positive leads within (1.8 m) 72 inches of the battery(s). To order a circuit breaker kit, contact your local Service Dealer, request kit number **MM5870**. See the “**Accessories**” section of this manual for more information.

## Operating Safety

1. Observe all boating safety guidelines as outlined by the US Coast Guard or by the governing agency for your area. Guidelines are typically posted at your local marina.
2. Do not operate the trolling motor while under the influence of alcohol or while taking medication that may impair your judgment.
3. Be aware of the possibility of unseen, underwater obstacles when navigating in shallow water, keep the boat speed down to a safe level.
4. When navigating near shore, watch for overhead obstacles such as tree limbs and floating dock tie-down cables.
5. When steering your motor, pay attention to your speed to determine a safe rate at which to turn without throwing passengers off balance.
6. Before turning the prop on, observe the direction the motor is pointing to avoid abrupt turns that could throw passengers off balance.
7. When the power is off but the motor is plugged in, keep your hands and feet away from the propeller.
8. Always unplug the battery when performing motor maintenance.
9. To avoid a trip hazard, route all cables and wiring neatly and out of the way.
10. Disconnect the trolling motor from the battery when it's not in use.

## Wireless Saltwater Models

Periodically lubricate all of the pivot points with silica based grease. Never use an aerosol lubricant to grease or oil any part of the unit. Many spray lubricants contain harmful propellants that can cause damage to various parts of your trolling motor.

# MOTORGUIDE WIRELESS

---

---

Thoroughly rinse your trolling motor with freshwater after each use in saltwater.

Corrosion on the metal components of the trolling motor occurs when two or more metals that are dissimilar are brought into electrical contact under water.

The use of a sacrificial anode causes all of the other metals on the trolling motor to become the cathodes. The anode will corrode and the trolling motor will not.

**Maintenance:** If excessive corrosion occurs, replace the anode. To order a Wireless Sacrificial Anode Kit contact your local Service Dealer, request kit number **MM5870**.

## NOTES:

---

---

---

---

---

---

---

---

---

---

---

---

---

---

---

---

---

---

---

---

---

---

---

---

---

# MOTORGUIDE WIRELESS

---

---

## FEATURES

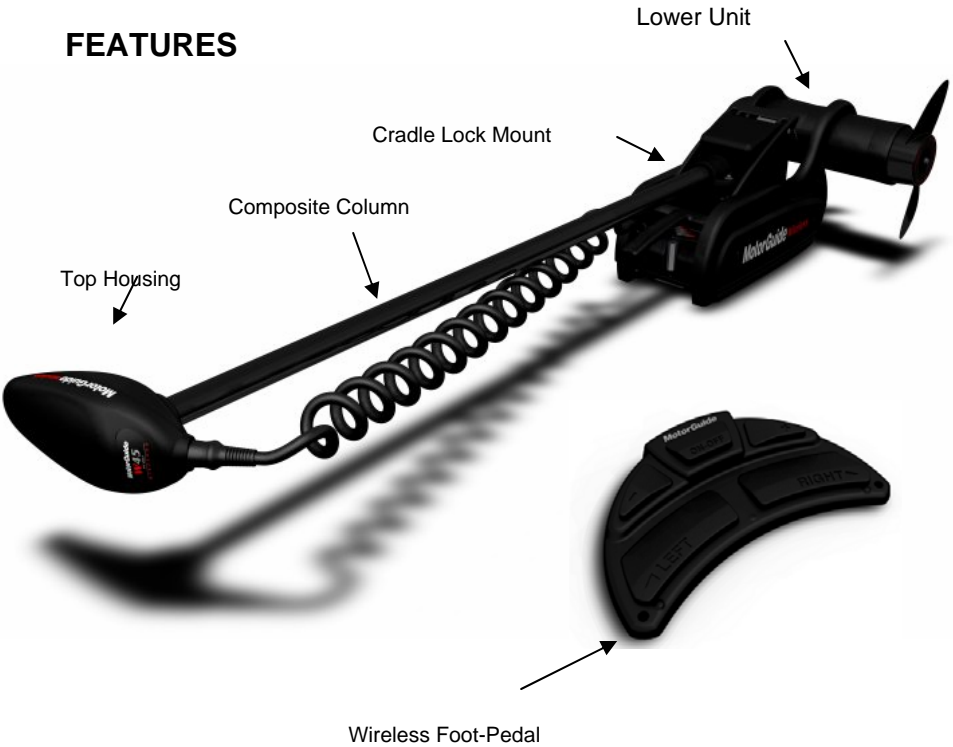

### Remote Capabilities

The MotorGuide Wireless uses a remote foot-pedal with the receiver built into the trolling motor mount. These remote capabilities work with the Digital Remote Control (DRC) product and up to four remotes (including the foot-pedal) can be used with one motor. See the “**Accessories**” section of this manual for more information.

### WARNING

**Modifications to this remote device not expressly approved by the manufacturer may invalidate the user’s right to operate this equipment.**

# MOTORGUIDE WIRELESS

---

---

## COMPONENTS

### Wireless Remote Foot-Pedal

The remote foot-pedal functions include the off/on, right/left and faster/slower motor operations. The anti-slip design makes motor operation easy for the angler wearing large boots. The battery used in the foot-pedal is long-life, inexpensive and replacement is easy.

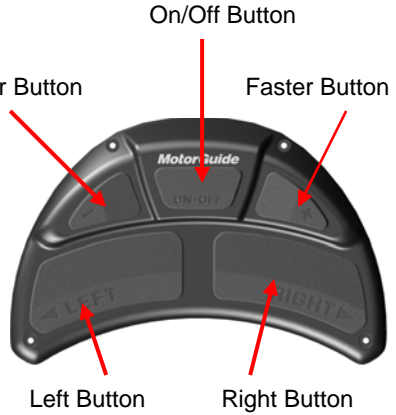

### Lower Unit

The lower unit is available in a 12 or 24 volt variable speed motor. The oversized brushes increase battery life and extend trolling time.



### Column

The MotorGuide Wireless composite shaft is exceptionally strong, and flexible. The shaft comes in 48, 54 and 60 inch lengths.

### Top Housing

The sleek top housing design indicates, at-a-glance, the direction of the motor. Additionally, no electrical boards are located in the top housing and it attaches to the shaft with a single through bolt. The rock-solid connection between the top housing and cable serves as an ergonomic handle.



# MOTORGUIDE WIRELESS

---

---

## Prop

The MotorGuide Wireless uses the 3½ inch two blade Power Prop.

## Cradle Lock™ Mount

The rock solid design of the MotorGuide Wireless mount has a quick-release mounting plate and an easy access lever for trouble-free stowing and deploying the motor. The mount also features a cradle that protects the motor during rough-water runs.



## Battery Indicator

The MotorGuide Wireless is equipped with a battery charge indicator. The push button gauge provides the angler an accurate reading of the remaining battery charge. Battery charge readings include:

- ▶ Good
- ▶ Fair
- ▶ Low and
- ▶ Recharge.



Test the battery with the motor off.

## Digital Remote Control – Optional Accessory

Fingertip control is available with MotorGuide's optional Digital Remote Control (DRC) wireless handheld. With the added value of a built-in receiver, you are now free to move about the deck. Mix and match up to four DRC handhelds or Wireless Foot-pedals in any combination. Perfect for tournament situations and/or tough bites that require teamwork, precise boat control and accurate bait presentations.





# MOTORGUIDE WIRELESS

---

---

## INSTALLATION

### Mount Installation

It is recommended that two people install the motor and mount.

### WARNING

**Do not connect the motor to a power source until the motor and mount are fully installed on the boat.**

The tools required for the installation are:

- 1) Drill with (8 mm)  $\frac{5}{16}$  inch drill bit
- 2) #3 Phillips head screw driver
- 3)  $\frac{1}{2}$  inch open end wrench

- 1) Carefully select the area on the deck as close to the centerline as possible to install the mount. Choose an area where the mount will provide ample clearance from the bow of the boat for all of the motor positions including the run and stow positions. A 1 to 2  $\frac{1}{2}$  inch clearance is needed between the shaft and the bow of the boat. Ensure the forward mounting screws are placed in a location on the deck where there is enough room to install the screws and washers without penetrating the hull.

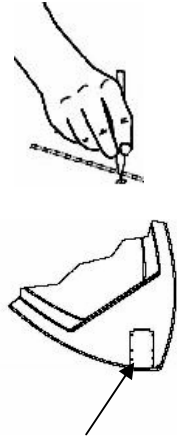

- 2) Remove the mount base plate from the mount installation kit and place it on the surface of the boat deck where it is to be mounted; use the mount plate

as a template to mark the location for drilling the mount holes.

Mount Base Plate on Boat Deck



### INFORMATION

**The end of the mount base plate with the large hook flange must be positioned forward on the bow of the boat.**

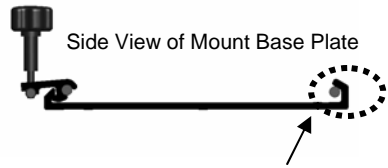

Side View of Mount Base Plate

Position Large Flange Hook Forward on Boat

- 3) Drill mounting holes with a (8 mm)  $\frac{5}{16}$  inch drill bit and then clear the holes of any debris. On fiberglass boats, chamfer the holes to help reduce the possibility of the fiberglass cracking.

# MOTORGUIDE WIRELESS

- 4) Place the mount base plate on the boat deck aligning the holes on the plate to the holes on the deck. Install the four (4) stainless steel mounting bolts through each of the mounting holes.
- 5) Install the four (4) stainless steel washers and nuts on the bottom side of the deck and tighten securely.
- 6) Remove the packaging material, in the box, from around the trolling motor.
- 7) Lift the motor and mount out of the box, turn the mount upright and lay it on a flat surface. Loosen the mount locking knob, located at the back of the mount housing, until it can pivot approximately 25 degrees.

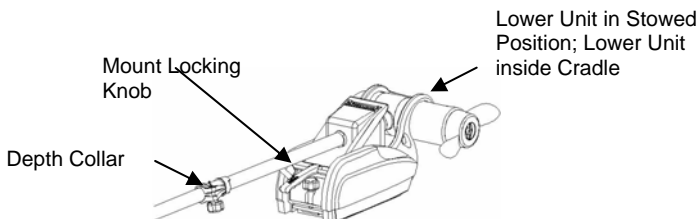
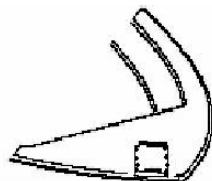

- 8) The motor is shipped with the lower unit and mount in the stowed position, but the lower unit must be placed into the locking cradle before proceeding. Pull up on the release handle to unlock the transmission. Slide and pivot the lower unit as needed to snap the lower unit inside the locking cradle.

- 9) Lift the motor and mount and place it over the mount base plate. The end of the mount housing with the lower unit cradle and lower unit is placed forward over the mount base plate. Guide the end of the mount with the

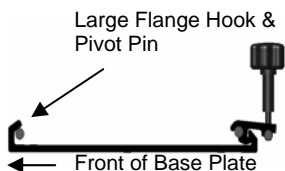
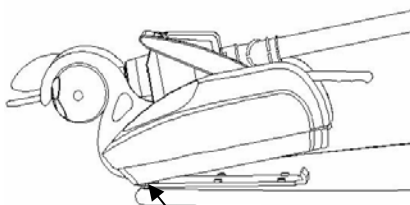

lower unit at an approximate 10° downward angle over the base plate until the pivot pin on the underside of the mount fits into the large flange hook on the base plate.

Lower Unit Cradle Placed Forward over Mount Base



# MOTORGUIDE WIRELESS

- 10) Sit the back of the mount housing over the back of the mount base. Press down on the back of the mount base and turn the mount locking knob just enough to engage the cam locking mechanism and secure the mount onto the base plate. Complete tightening the cam locking mechanism in step 12 below.

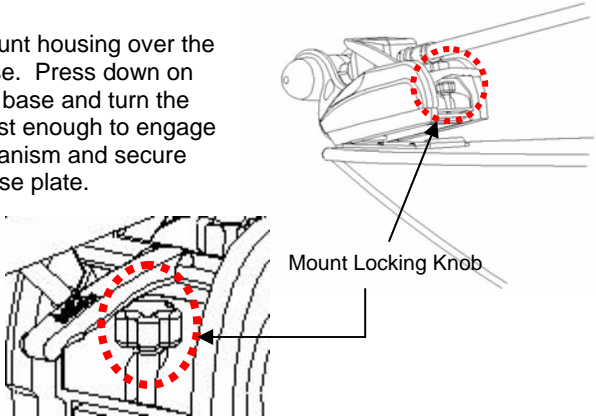

- 11) Position the depth collar on the shaft so that the lower unit will not strike any obstacles (boat trailer, ground, etc.) when the motor is deployed and then deploy the motor to the run position (see **Motor & Mount Operation, Deploying the Motor** for complete instructions on deploying the motor).

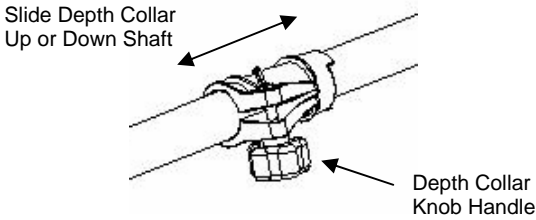

- 12) Deploy the motor into the run position and then tighten the lock completely by turning the mount lock knob.

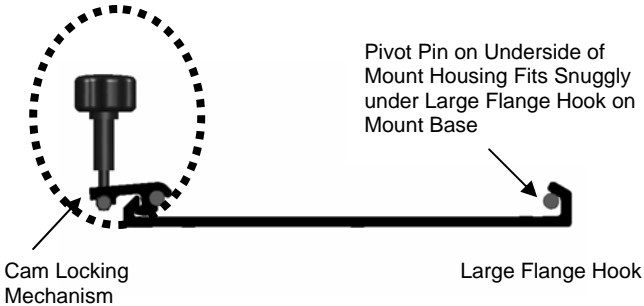

Side View of Mount Base Plate

# MOTORGUIDE WIRELESS

---

---

For storage and security purposes the MotorGuide Wireless Cradle Lock™ mount makes it easy to completely remove and reinstall the mount and motor. When the mount and motor are removed from the boat, a snap-on Wireless Mounting Plate Cover (see the **Accessories** section of this manual for order information) is available to protect the mounting plate.

## Wiring & Battery Information

### **WARNING**

Batteries contain sulfuric acid which can cause severe burns. Avoid contact with skin, eyes, and clothing. The battery also produces hydrogen and oxygen gasses when being charged. This explosive gas is released through the battery vents and may form an explosive atmosphere around the battery for several hours after it has been charged. Electrical arcing or flames can ignite the gas and cause an explosion which may shatter the battery and could cause blindness or other serious personal and property damage. Refer to your battery manufacturer's guidelines for charging instructions.

### **WARNING**

Be sure all switches are in the OFF position before connecting the motor to the batteries. Electrical arcing near the battery could ignite gas vapors causing an explosion.

### **WARNING**

Avoid serious injury or death from a possible fire caused by a direct short; do not jump-start an outboard motor using the trolling motor battery/batteries.



## Wire & Cable Routing

- ▶ Route trolling motor wires on the opposite side of the boat from other miscellaneous boat wiring (bow light wiring, spot light wiring, etc.).
- ▶ MotorGuide does not recommend using an external sonar transducer on the Wireless trolling motor line. See your nearest MotorGuide Service Center about installing a conversion kit for an internal sonar transducer. Refer to [www.motorguide.com](http://www.motorguide.com) or contact Mercury Marine Consumer Affairs at 1-920-929-5040 for a complete listing of compatible sonar units.

# MOTORGUIDE WIRELESS

---

---

- ▶ Electronics, depth finders in particular, should be connected directly to the main engine or an accessory battery. Do not connect your electronics to the trolling motor battery.



## Establishing a Common Ground

MotorGuide recommends isolating the trolling motor battery/batteries from the main engine battery.

**Electrolysis Issues** – Using the engine starting battery as a source of power for any trolling motor may cause electrolysis on metallic parts.

- ✓ If you have followed the battery wiring and installation instructions in this manual and your boat continues to have electrolysis issues, you will need to separate the trolling motor from any other boat electronics.
  - ✓ Remove the engine starting battery from the wiring configuration of the boat and isolate the power circuit for your trolling motor.
- ▶ **Establish a Common Ground:** Common ground means the ground for the main engine accessories and your trolling motor are connected to the same negative ground terminal.
  - ▶ Not having a common ground can cause severe corrosion or electrolysis. If left unchecked, damage may be caused to your trolling motor and boat.
  - ▶ Establishing a common ground connection will allow increased sensitivity and improve detail on a sonar display.



## Recommendations

- ▶ **Battery Type** – The recommended battery is a 12-volt Deep Cycle battery.
- ▶ **Circuit Protection** – MotorGuide recommends installing a 50 amp manual-reset circuit breaker in line with the trolling motor positive leads within (1.8 m) 72 inches of the battery(s). To order a circuit breaker kit, contact your local Service Dealer, request kit number **MM5870** or a 50 amp circuit breaker and a power switch.
- ▶ **Wire Size** – For optimum performance, MotorGuide recommends the use of six (6) gauge (13 mm) wires if extending the existing wire beyond the standard battery cable supplied with the product.
- ▶ **Bow Plugs** – MotorGuide recommends the use of a quality plug designed

# MOTORGUIDE WIRELESS

for marine applications.

## 12 Volt Battery Hook-up

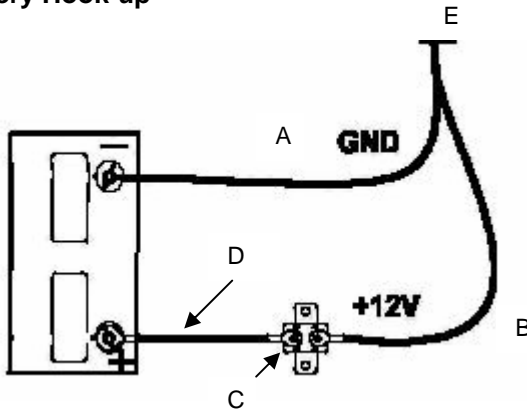

- |  |                                       |
|--|---------------------------------------|
| A) Black battery lead (-)                          | D) Jumper Wire                        |
| B) Red battery lead (+)                            | E) To trolling r<br>motor connections |
| C) 50 amp circuit<br>Breaker and a power<br>switch |                                       |

Connect the red battery lead from the power cable to the battery positive (+) post and the black battery lead from the power cable to the battery negative (-) post. Install a 50 amp circuit breaker and a power switch in line with the positive lead as shown in C above. (See the “**Assessories**” section in this manual for the circuit breaker and power switch part number.)

### **WARNING**

**Observe installation guidelines when connecting the motor to the batteries. When in doubt, consult a professional at your nearest dealer.**

- ▶ **Always connect to the battery through a power plug which can be easily disconnected or through an easily accessible power switch. Never “hardwire” the motor directly to the batteries.**
- ▶ **Always use the recommended circuit breaker to protect the wires.**

# MOTORGUIDE WIRELESS

## 24 Volt Battery Hook-up

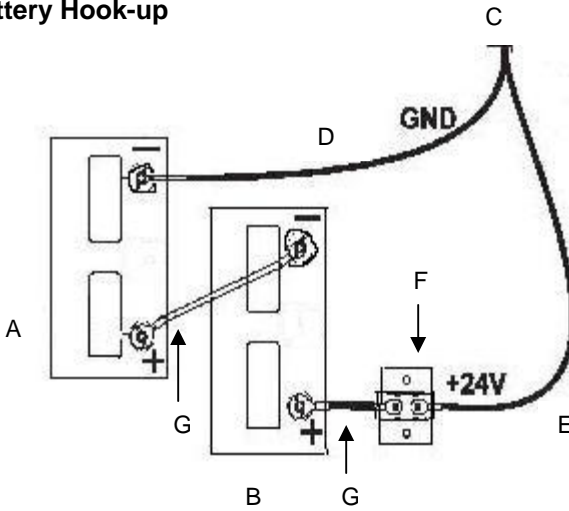



- |                                  |  |
|----------------------------------|--|
| A) Battery A                     | E) Red battery leads (+)                     |
| B) Battery B                     | F) 50 amp circuit breaker and a power switch |
| C) To trolling motor connections | G) Jumper wires                              |
| D) Black battery leads (-)       |  |

Connect the black battery lead from the power cable to the negative (-) post on battery A and the red lead from the power cable to the positive (+) post on battery B. Connect a jumper wire between the negative (-) post of battery A and the positive (+) post of battery B. Install a 50 amp circuit breaker in line with the positive lead to battery B as shown above. (See the **“Assessories”** section in this manual for the circuit breaker and power switch part number.)

### **WARNING**

**Observe installation guidelines when connecting the motor to the batteries. When in doubt, consult a professional at your nearest dealer.**

-  **Always connect to the battery through a power plug which can be easily disconnected or through an easily accessible power switch. Never “hardwire” the motor directly to the batteries.**
-  **Always use the recommended circuit breaker to protect the wires.**

# MOTORGUIDE WIRELESS

---

---

## Activating the Foot-Pedal Electronic ID

Each foot-pedal has a unique electronic ID number. Up to four electronic ID numbers (Digital Remote Control units and/or foot-pedals) can be stored by your receiver. For your foot-pedal to respond to your commands only and not those of other boaters, you must activate the electronic ID number into your receiver. Follow the instructions below (one time only) to activate each new remote control device:

1. **Connect the motor to a power source - within 10** seconds, press and hold the “+” and “-“ buttons on the foot-pedal simultaneously
2. Listen for a long beep
3. The receiver has now learned and stored the electronic ID number of the foot-pedal.



### NOTE

**If you are activating multiple remote control devices (up to four devices can be accommodated) the motor must be disconnected from the power source and reconnected to the power source between activating each remote control device.**

## Erasing the Receiver’s Memory

To erase all electronic ID numbers stored in the receiver’s memory:

1. Power-up the motor
2. Within 10 seconds, press and hold the “Left”, “Right”, “+” and “-“ buttons on the foot-pedal simultaneously
3. Listen for a long beep indicating the receiver has erased all stored electronic ID numbers

# MOTORGUIDE WIRELESS

---

---

## MOTOR & MOUNT OPERATION

### Adjusting the Motor Depth and Deploying the Motor

1. Loosen the depth collar by turning the knob handle. Slide the depth collar up or down the shaft to a position that will allow the lower unit to be submerged at least 12 inches (30cm) below the water surface when the motor is fully deployed. When the depth collar is in the desired location, turn the depth collar handle to tighten. Also, be cautious that the depth of the motor is deep enough to prevent the lower unit from striking obstacles that could damage the skeg or prop.

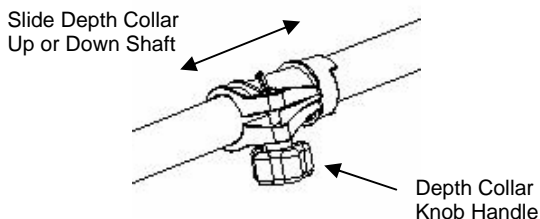

2. Pull up on the release handle and then raise the motor out of the stow position.

Motor in Stowed Position

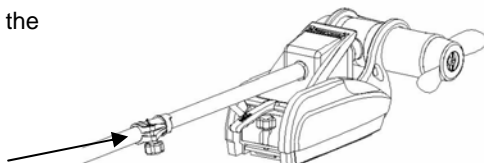

3. Hold the motor by the shaft or the top housing and raise it into a vertical position. Lower the motor until the depth collar rests on top of the mount housing collar. The motor is ready to connect to the power source.

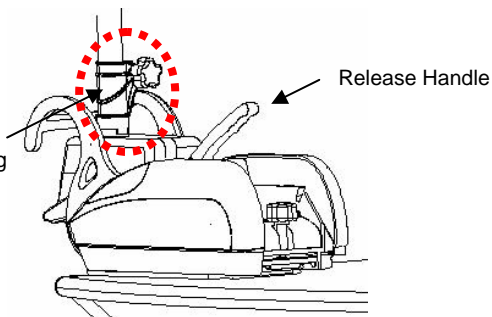

# MOTORGUIDE WIRELESS

## Stowing the Motor

1. Pull up the release handle and then, holding the shaft or top housing, lift the motor up.

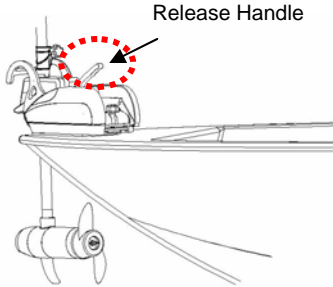

2. While lifting the motor out of the water, rotate the shaft until the lower unit is aligned with the locking cradle.

Lower Unit Aligned with  
Locking Cradle

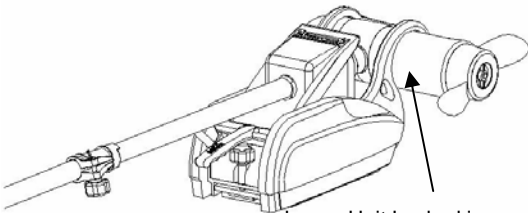
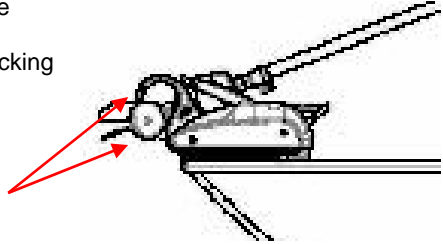

Lower Unit Locked in  
Cradle

3. Continue to pull the lower unit up to the mount until the lower unit can be snapped into the cradle.

Push Down on the Column to  
lock the Release Handle

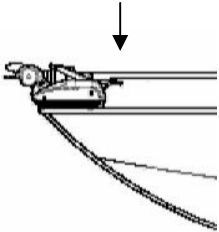

4. Push down on the column to lock the cradle and to lock the release handle. You will hear a click when the lower unit and release handle are locked into position.



# MOTORGUIDE WIRELESS

---

---

## Operating the Foot-Pedal

### INFORMATION

Ensure the foot-pedal electronic ID has been activated. See the **“Installation”** section of this manual for instructions.

1. **Prop On/Off**  
**Turn the prop on or off by pressing the center button** and it will alternate between on and off. The “on” condition is indicated by a short beep while “off” is indicated by a long beep.

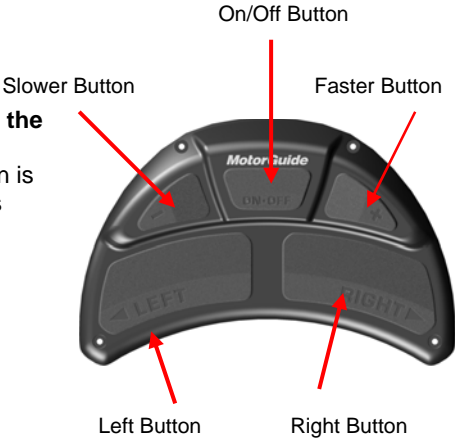

2. **Steering: Press the left or right arrow buttons to steer the boat.** Each button press steers the motor left or right one step; holding down a button will rapidly steer the motor in the direction of the selected arrow.
3. **Speed: Use the + and – buttons to control the motor speed,** a beep will sound each time the + or – buttons are pushed. Holding the button down will rapidly speed-up or slow-down the motor until it reaches minimum or maximum speed; once at the limit, the receiver will no longer beep when you press a button.

# MOTORGUIDE WIRELESS

---

---

## MAINTENANCE

### Foot-Pedal Battery Replacement

Use only a 3V lithium type CR2032 replacement battery. **These batteries are not rechargeable.** Follow these instructions to change the battery:

1. Remove the five screws on the battery cover plate located on the underside of the foot-pedal.

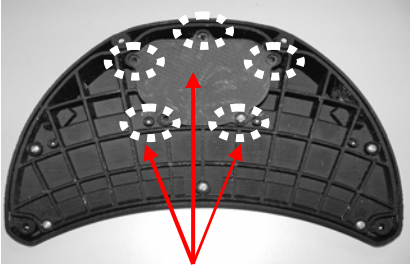

Location of Screws Securing Battery Cover Plate to Foot-Pedal

2. Remove the battery cover plate.
3. Using a pencil, push the battery out of its holder.



4. With the “+” symbol facing up, slide the new battery in the holder.

5. Ensure the O-ring is in place on the cover. Replace plate and five



ring is in inside the cover screws.

# MOTORGUIDE WIRELESS

---

---

## Care & Cleaning Instructions

To keep your trolling motor looking its best:

1. Periodically wash it with warm soapy water and a soft cloth or sponge.
2. Do not use a high pressure or power washer.
3. Use a vinyl/rubber UV protector, available in any auto store, to keep the cables looking fresh.
4. Never use harsh chemicals, alcohol, solvents or abrasives on the motor plastics, rubber or painted parts.

## Customer Responsibilities

The motor/mount warranty does not cover items that have been subjected to operator abuse or negligence. To receive full value from the warranty, the motor/mount must be maintained as instructed in this manual.

▶	Check behind the propeller after each use to ensure weeds, fishing line or other debris are not wrapped around the propeller or the propeller shaft.
▶	Periodically lubricate all the latch pins and clamp screws with a non-aerosol lubricant. Never use an aerosol lubricant to grease or oil any part of the unit. Many spray lubricants contain harmful propellants that can cause damage to various parts of your trolling motor.
▶	Check the tightness of the battery lead connections.
▶	Periodically inspect for loose or corroded wiring connections.
▶	Thoroughly rinse your trolling motor with freshwater after each use in brackish water.
▶	Periodically make a visual inspection for tightness of all nuts, bolts and screws.
▶	Before or after use, periodically check the prop nut for tightness.

## Battery

Recharge your batteries after each use. Follow the battery manufacturer's recommendations for battery maintenance. Have your batteries tested annually to ensure quality of operation.



### CAUTION

Always disconnect the trolling motor battery when not in use.

# MOTORGUIDE WIRELESS

---

---

## Freezing Temperature Storage

Store your trolling motor where it will not be affected by freezing temperatures.

## Installing or Replacing the Propeller

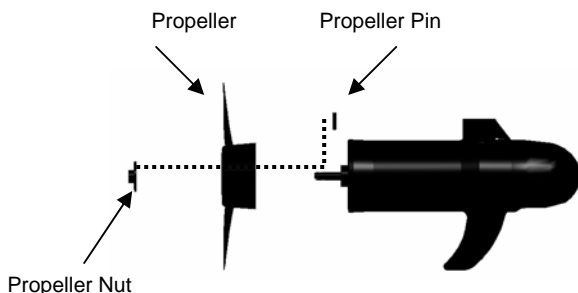

See the “**Accessories**” section of this manual to order a replacement propeller.



### CAUTION

**Make sure the motor is disconnected from the battery before replacing the propeller.**



### CAUTION

**Do not strike a bent prop pin with a hammer to remove the pin. This may cause damage to the armature, which is not covered by warranty. MotorGuide recommends using pliers.**

- 1) When handling the prop, first check for sharp edges or wear protective gloves to prevent cuts to the hands.
- 2) While holding the propeller blade, use a prop wrench to loosen and remove the propeller nut.
- 3) Pull the propeller straight off. If the prop is stuck, grasp one blade with one hand and tap lightly on the backside of the opposite blade with a rubber

## MOTORGUIDE WIRELESS

---

---

mallet. If necessary, repeat the procedure on all blades until the propeller comes off.

- 4) If the propeller pin is bent, replace it.
- 5) Align the new propeller with the propeller pin.
- 6) Reinstall the propeller nut and tighten securely with your fingers. Tighten another 1/4 turn using a MotorGuide Prop Wrench, part number **MGA050B6**.

# MOTORGUIDE WIRELESS

---

---

## TROUBLESHOOTING

### Frequently Asked Questions

- Q** The receiver beeps when I press a button on the foot-pedal but nothing happens.
- A** The receiver does not have the foot-pedals electronic ID number programmed; refer to the “*Activating the Electronic ID number*” section of this manual.
- Q** **Activating the electronic ID number does not work.**
- A** The receiver’s memory might be full, see the “*Erasing the Receiver’s Memory*” section of this manual.
- Q** **I hit an underwater object and the motor quit working. I pressed the test button on the battery indicator and all of the lights came on at once.**
- A** All lights on the battery indicator illuminated at once means the steering or trolling motor have been overloaded. Wait for the unit to cool down. Then power cycle the motor by unplugging the motor from the battery and then plug it back in. If the system does not return to normal after cooling or power cycling, contact your nearest Service Center.
- NOTE: This motor protection feature also occurs if the steering is jammed by hitting an underwater object. To correct, follow the same power cycling procedure explained above.**
- Q** **The system stopped working.**
- A** Check the battery in the foot-pedal and replace if necessary.
- Q** **I was running the motor, turned it off and then turned it back on but the motor did not resume at the previous speed.**
- A** The motor temporarily lost the battery connection. Check all of the battery connections to ensure they are clean and tight.

PROBLEM	POSSIBLE CAUSES AND/OR SOLUTIONS
Loss of power	<ul style="list-style-type: none"><li>• The propeller may be fouled. Remove the propeller; clean or replace if necessary.</li><li>• The battery connections may be corroded.</li><li>• The battery may have low voltage. Recharge and test for a bad cell.</li><li>• The wire gauge from the battery to the trolling motor may be insufficient. (Six-gauge wire is recommended.)</li><li>• A bad or faulty connection or pinched wire could</li></ul>

## MOTORGUIDE WIRELESS

	<p>exist in the boat wiring or trolling motor wiring.</p> <ul style="list-style-type: none"> <li>• The permanent magnets may be cracked or chipped. The motor will whine or grind.</li> <li>• There may be water in the lower unit.</li> </ul>
Motor makes excessive noise or vibrates excessively	<ul style="list-style-type: none"> <li>• The propeller may be fouled. Remove the propeller; clean or replace if necessary.</li> <li>• The propeller may be loose. Check to see if the propeller is secure.</li> <li>• The armature may be bent. Remove the propeller and set the motor at medium speed. Turn the unit on and look for the shaft to wobble.</li> <li>• The magnets may be interfering with the armature. Turn the power is off. Turn the prop by hand; it should turn freely with a slight magnetic drag.</li> <li>• The bearings or bushings may be worn out.</li> </ul>
Motor fails to run at any speed	<ul style="list-style-type: none"> <li>• Check the trolling motor fuse/circuit breaker on the boat.</li> <li>• Check for loose or corroded connections.</li> <li>• Check the plug for a loose or bad connection.</li> <li>• Make sure the power is off. Turn the prop by hand; it should turn freely with a slight magnet drag.</li> </ul>
Motor loses one or more speeds	<ul style="list-style-type: none"> <li>• The propeller may be fouled. Remove the propeller; clean or replace if necessary.</li> </ul>
Mount is hard to latch to the mount base plate	<ul style="list-style-type: none"> <li>• Your bow mount is designed to easily release when the cam locking mechanism is loosened. If it does not easily release, check to ensure the cam lock is loosened and that the mount base plate is mounted evenly on the boat deck.</li> <li>• The pivot pin on the underside of the mount may not be secured by the large flange hook.</li> <li>• It is also possible that the cam lock mechanism at the back of the mount it not fully engaged. Check to ensure the cam lock is properly tightened.</li> </ul>
Battery drains	<ul style="list-style-type: none"> <li>• Voltage drain will occur if your motor remains continually connected to your battery. Install a power disconnect switch or disconnect the trolling motor.</li> </ul>
Motor automatically throttles back	<ul style="list-style-type: none"> <li>• Refer to your nearest Service Dealer for assistance with trolling motor repairs.</li> </ul>

# MOTORGUIDE WIRELESS

---

---

## INFORMATION

Refer to your nearest Service Dealer for assistance with trolling motor repairs.

### **FOR REPAIR SERVICE**

Contact your nearest MotorGuide Service Dealer. See a complete listing of Service Dealers in the US and Canada at our MotorGuide web site: [www.motorguide.com](http://www.motorguide.com).

Call Mercury Marine **Consumer Affairs** to obtain the name and location of the Service Dealer nearest you.

<b>United States:</b>	<b>1-920-929-5040</b>
<b>Australia Pacific:</b>	<b>61-3-9791-5822</b>
<b>Canada:</b>	<b>905-816-4751</b>
<b>Europe, Africa &amp; Middle East:</b>	<b>32-87-323-211</b>
<b>Japan:</b>	<b>81-53-423-2500</b>
<b>Latin America:</b>	<b>954-744-3500</b>
<b>Singapore:</b>	<b>65-6546-6160</b>

### **REPLACEMENT PARTS AND ORDERING**

MotorGuide has established Service Dealers as Parts Distributors throughout the United States and Canada. Have the following information ready and contact the nearest Service Dealer to order parts:

- Model Number
- Serial Number
- Part Number



# MOTORGUIDE WIRELESS

---

---

## MOTORGUIDE ACCESSORIES

**Making It More Perfect.** Who says you cannot make the best even better? MotorGuide® factory accessories let fishermen customize motors to their own unique needs. In addition, every one is a perfect fit.

### REPLACEMENT PROPS

Prop	Description	Number
#12	3.5" 2 Blade Power Prop	MGA0495
#16	3.5" Machette III, 3 Blade	MGA087B



### ADDITIONAL HARDWARE ACCESSORIES



#### Snap-on Wireless Mounting Plate Cover MGA506A1

Protective cover converts mounting plate to a step when your trolling motor is not in use.



#### Prop Wench

MGA050B6

Comes complete with spare prop nut and two prop pins, allowing fast prop changes.

#### 50 Amp Circuit Breaker

MM5870

Protects trolling motor and boat wiring from connection failures and is a safety must.



#### DRC-Remote Control

M887657

Digital RF  
Wireless  
Remote Key  
FOB



# MOTORGUIDE WIRELESS

---

---

## MOTORGUIDE LIMITED THREE-YEAR WARRANTY

(Keep your original purchase receipt)

For recreational use customers, MotorGuide Wireless Series electric trolling motors are warranted to the original retail purchaser<sup>1</sup> to be free from defects in material and/or workmanship for a period of three (3) years from the date of purchase. This Limited Warranty begins on the date the product is first sold to a retail purchaser or the date on which the product is first put into service, whichever occurs first. Commercial<sup>2</sup> users of these products receive coverage for one (1) year from the date of first retail sale. MotorGuide Accessories are covered by this Limited Warranty for a coverage period of one (1) year from the date of retail sale.

### MotorGuide Wireless Series Composite Shaft Limited Lifetime Warranty

MotorGuide Wireless composite shafts are warranted to the original retail purchaser to be free of defects in material and/or workmanship for the lifetime of the original purchaser (3). MotorGuide will provide a new Wireless composite shaft at no cost for any Wireless composite shaft which contains a defect in material or workmanship. The installation costs are the sole responsibility of the purchaser.

This warranty does not cover product damage due to abuse, i.e., bent armature shafts, broken control cables, etc., accidents, modifications, misuse, excessive wear or damage caused by an owner's failure to provide reasonable and necessary installation or care. Opening the lower unit (motor) by anyone other than an authorized Service Dealer will void this warranty. To obtain warranty service, the purchaser should deliver or return the unit (postage prepaid and insured) to any MotorGuide Authorized Service Dealer. Products returned by mail should also be carefully packaged and include a note describing the nature of the problem and/or service requested. A copy of the proof of purchase or registration verification is required with the return of the product for warranty consideration. MotorGuide, at its discretion, will repair or replace items covered under the terms of this warranty. Neither MotorGuide nor MotorGuide Service Dealers are responsible for damages to MotorGuide products due to repairs performed by anyone other than an authorized MotorGuide Service Dealer. Neither MotorGuide nor Mercury Marine is responsible for failure or damage caused by improper installation, set-up, preparation, or previous service or repair errors.

The product registration must be processed by MotorGuide within ten (10) days from the date of purchase to validate your warranty. MotorGuide products requiring service not covered under the terms of this warranty may be repaired or replaced for a reasonable fee. ALL INCIDENTAL AND/OR CONSEQUENTIAL DAMAGES ARE EXCLUDED FROM THIS WARRANTY. IMPLIED WARRANTIES ARE LIMITED TO THE LIFE OF THIS WARRANTY. SOME STATES DO NOT ALLOW LIMITATIONS ON HOW LONG AN IMPLIED WARRANTY LASTS OR THE EXCLUSION OR LIMITATION OF INCIDENTAL OR CONSEQUENTIAL DAMAGES, SO THE ABOVE LIMITATIONS OR EXCLUSIONS MAY NOT APPLY TO YOU. THIS WARRANTY GIVES YOU SPECIFIC LEGAL RIGHTS, AND YOU MAY ALSO HAVE OTHER LEGAL RIGHTS WHICH MAY VARY FROM STATE TO STATE.

For Your Records:

Model Number \_\_\_\_\_

Serial Number \_\_\_\_\_

<sup>1</sup>Warranty is transferable to any subsequent purchaser for the duration of the unused warranty period.

<sup>2</sup> Commercial use is defined as any work or employment-related use of the product, or any use of the product which generates income, for any part of the warranty period, even if the product is only occasionally used for such purpose.

3. Original purchaser lifetime warranty is not transferable.

## MOTORGUIDE WIRELESS

---

---

**IMPORTANT!!**

**REGISTER YOUR**



**PRODUCT**

The warranty registration card (located in the box) should be completed and mailed to Mercury Marine to validate your warranty. To replace a lost warranty card, contact the Mercury Marine Registration Department at 1-920-929-5054.

---

---

**WARRANTY CARD  
REGISTRATION  
IS INCLUDED IN THE BOX AND IS SEPARATE  
FROM THIS MANUAL.**

**PLEASE FILL OUT AND MAIL IMMEDIATELY TO  
VALIDATE YOUR WARRANTY.**

---

---

Thank you for purchasing and registering  
this MotorGuide product.

---

---

**MotorGuide®**  
**NEVER STOP.**

MotorGuide  
835 W. 41<sup>st</sup> Street  
Tulsa, Oklahoma 74107  
(920) 929-5040

---

---